

36-75V Input, 3.3V / 18A / 60W Output Very High Density Isolated DC-DC Converter (400W/in³)

Description

The Cool-Power™ PI3101 is a very high density isolated DC-DC converter implementing a high efficiency soft-switching power architecture. The PI3101 operates over a wide range input of 36V to 75Vdc, delivering ~60W of output power (3.3Vout @ 18A), yielding an unprecedented power density of 400W/in³. The PI3101 is available in a space saving surface mountable 0.87" x 0.65" x 0.265" package, achieving ~50% space reduction versus conventional solutions.

The switching frequency of 900kHz allows for small input and output filter components which further reduces the total size and cost of the overall system solution. The output voltage is sensed and fed back to the internal controller using a proprietary isolated magnetic feedback scheme which allows for high bandwidth and good common mode noise immunity. The PI3101 requires no external feedback compensation and offers a total solution with a minimum number of external components. A rich feature set is offered, including output voltage trim capability, output over-voltage protection, adjustable soft-start, over-current protection with auto-restart, over and under input voltage lockout and a temperature monitoring and protection function that provides an analog voltage proportional to the die temperature as shut down and alarm capabilities.

Features

- Efficiency up to 87%
- High switching frequency minimizes input filter requirements and reduces output capacitance
- Proprietary "Double-Clamped" ZVS Buck-Boost Topology
- Proprietary isolated magnetic feedback
- Small footprint (0.57 in²) enables PCB area savings
- Very low profile (0.265 in)
- Wide input voltage range operation (36-75Vdc)
- On/Off Control, positive logic
- +10/-10% Trim
- Temperature Monitor (TM) & Over-Temperature Protection (OTP)
- Input UVLO & OVLO and output OVP
- Over current protection with auto restart
- Adjustable soft-start
- 2250V input to output isolation

Applications

- Power Over Ethernet (PoE)
- Communications
- Telecom Systems
- Network Power

Package Information

- Surface Mountable 0.87" x 0.65" x 0.265" package

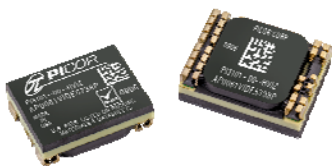

PI3101-00-HVIZ
36-75Vin, 3.3Vout, 18A
Very High Density Isolated DC-DC Converter

Typical Application Schematic Diagram

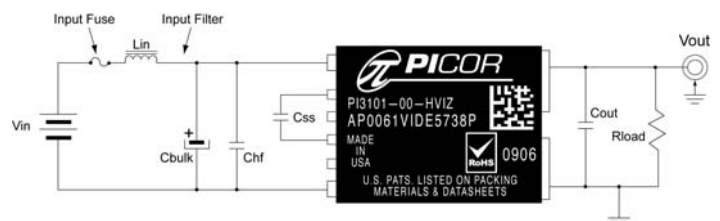

Figure 1 Picor PI3101 Shown With System Fuse, Filter, Decoupling And Extended Soft Start

Pin Description And Maximum Ratings



Figure 2 Picor PI3101-00-HVIZ Pin Out

Pin Description

Pin Name	Description
+IN	Primary side positive input voltage terminals.
-IN	Primary side negative input voltage terminals.
ENABLE	Converter enable option, functions as 5V reference and on/off control pin. Pull low for off.
TRIM/SS	External soft start pin and trim function. Connect to SGND or ENABLE through resistor for trim up or trim down.
TM	Temperature measurement output pin.
SGND	Signal ground, primary side referenced.
+OUT	Isolated secondary DC output voltage positive terminals.
-OUT	Isolated secondary DC output voltage negative terminals.

Absolute Maximum Ratings

+IN to -IN Max Operating Voltage	-1.0 to 75Vdc (operating)
+IN to -IN Max Peak Voltage	100Vdc (non-operating, 100ms)
ENABLE to -IN	-0.3 to 6.0Vdc
TM to -IN	-0.3 to 6.0Vdc
TRIM/SS to -IN	-0.3 to 6.0Vdc
+OUT to -OUT	-0.5 to 6.0Vdc
Isolation Voltage (+IN/-IN to +OUT/-OUT)	2250Vdc
Isolation Capacitance (+IN/-IN to +OUT/-OUT)	330pF
Continuous Output Current	18A DC (Tcase < 100°C)
Peak Output Current	34Adc (11mm heatsink, 600LFM)
Operating Junction Temperature	-40 to 125°C
Storage Temperature	-40 to 125°C
Case Temperature During Reflow	245°C

Functional Block Diagram

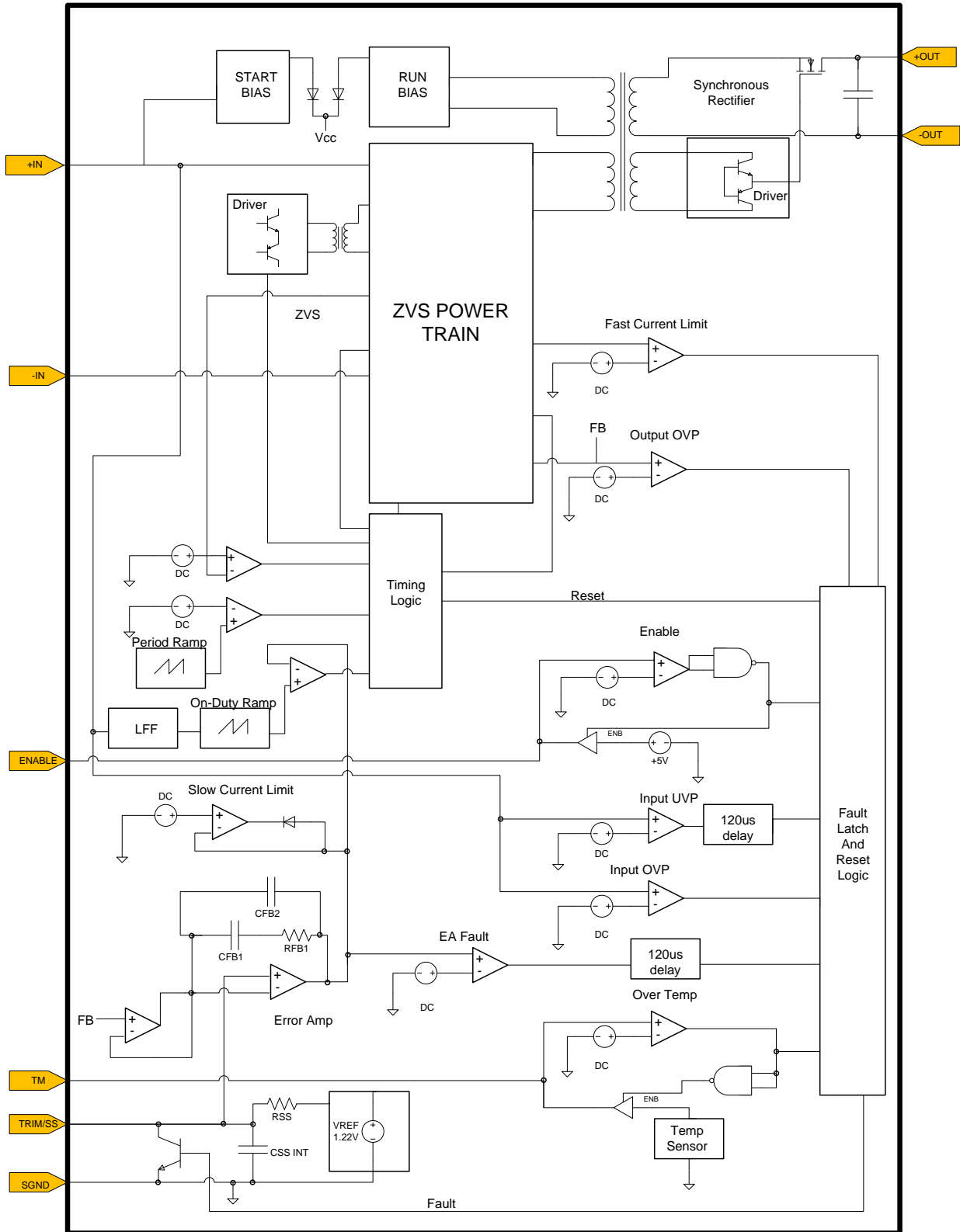

Figure 3 PI3101 Functional Block Diagram

Electrical Specifications

Unless otherwise specified: $36V < V_{IN} < 75V$, $0A < I_{OUT} < 18A$, $-40^{\circ}C < T_{CASE} < 100^{\circ}C^{(1)}$

Parameter	Symbol	Min	Typ	Max	Units	Conditions
Input Specifications						
Input Voltage Range	V_{IN}	36	48	75	Vdc	
Input dv/dt ⁽¹⁾	V_{INDVDT}			1.0	V/ μ s	$V_{IN} = 75V$
Input Under-Voltage Turn-on	V_{UVON}	32.5	34	35	Vdc	$I_O = 1.8A$
Input Under-Voltage Turn-off	V_{UVOFF}	30.5	32	33	Vdc	$I_O = 1.8A$
Input Under-Voltage Hysteresis	V_{UVH}		2		Vdc	$I_O = 1.8A$
Input Over-Voltage Turn-on	V_{OVON}	75.7	78	81	Vdc	$I_O = 1.8A$
Input Over-Voltage Turn-off	V_{OVOFF}	77.7	80	82.3	Vdc	$I_O = 1.8A$
Input Over-Voltage Hysteresis	V_{OVH}		2			$I_O = 1.8A$
Input Quiescent Current	I_Q		2.5		mAdc	$V_{IN} = 48V$, ENABLE = 0V
Input Idling Power	P_{IDLE}		4.0		W	$V_{IN} = 48V$, $I_{OUT} = 0A$
Input Standby Power	P_{SBY}		0.225		W	$V_{IN} = 48V$, ENABLE = 0V
Input Current Full Load	I_{IN}		1.4		Adc	$T_{CASE} = 100^{\circ}C$ $I_{OUT} = 18A$ $\eta_{FL} = 86.5\%$ typical $V_{IN} = 48V$
Input Reflected Ripple Current	I_{INRR}		10		mApp	$L_{IN} = 2\mu H$ $C_{IN} = 47\mu F$ 100V electrolytic + $2 \times 1\mu F$ 100V X7R ceramic
Recommended Ext Input Capacitance	C_{IN}		49		μF	$C_{IN} = 47\mu F$ 100V electrolytic + $2 \times 1\mu F$ 100V X7R ceramic $C_{IN} = C_{bulk} + C_{hf}$
Output Specifications						
Output Voltage Set Point	V_{OUT}		3.3		Vdc	$I_{OUT} = 9A$
Total Output Accuracy	V_{OA}	-3		+3	%	
Line Regulation	V_{RLI}		0.25		%	$V_{IN} = 36V-75V$, $I_{OUT} = 18A$
Load Regulation	V_{RLO}		1.5		%	$V_{IN} = 48V$, $I_{OUT} = 0-18A$
Output Voltage Trim Range	V_{OAJD}	-10%		10%	%	
Output Current Range	I_{OUT}			18	Adc	
Over Current Protection	I_{OCP}	18.8	26	33	Adc	
Efficiency – Full Load	η_{FL}	84.5	86.5		%	$T_{CASE} = 100^{\circ}C$, $V_{IN} = 48V$
Efficiency – Half Load	η_{HL}		84.5		%	$T_{CASE} = 100^{\circ}C$, $V_{IN} = 48V$
Output OVP Set Point	V_{OVP}		4.1		Vdc	
Output Ripple Voltage	V_{ORPP}		75		mVpp	$C_{OUT} = 12 \times 10\mu F$ 10V X7R DC-20MHz using PI3101-EVAL1
Switching Frequency	f_{SW}		900		kHz	
Output Turn-on Delay Time	t_{ONDLY}		80		ms	$V_{IN} = V_{UVON}$ to ENABLE = 5V

Electrical Specifications (continued)

Unless otherwise specified: $36V < V_{IN} < 75V$, $0A < I_{OUT} < 18A$, $-40^{\circ}C < T_{CASE} < 100^{\circ}C^{(1)}$

Parameter	Symbol	Min	Typ	Max	Units	Conditions
Output Specifications (continued)						
Output Turn-off Delay Time	t_{OFFDLY}		10		μs	$V_{IN} = V_{UVOFF}$ to $ENABLE < 1.8V$
Soft-Start Ramp Time	t_{SS}		380		μs	$ENABLE = 5V$ to 90% V_{out} $C_{SS} = 0$
Maximum Load Capacitance	C_{OUT}			10	mF	$V_{IN} = 75V$, 18A resistive load $C_{SS} = 1\mu F$
Load Transient Deviation	V_{ODV}		90	110	mV	$I_{OUT} = 25\%$ step 0.1A/ μS $C_{OUT} = 12 \times 10\mu F$ 10V X7R
Load Transient Recovery Time	t_{OVR}		120		μs	$I_{OUT} = 25\%$ step 0.1A/ μS $C_{OUT} = 12 \times 10\mu F$ 10V X7R $V_{OUT} - 1\%$
Maximum Output Power	P_{OUT}		60		W	
Auxiliary Control Pins						
ENABLE						
DC Voltage Reference Output	V_{ERO}	4.65	4.9	5.15	Vdc	
Output Current Limit ⁽²⁾	I_{ECL}	-3.3	-2.6	-1.9	mAdc	$ENABLE = 3.3V$
Start Up Current Limit ⁽²⁾	I_{ESL}	-120	-90	-60	μA	$ENABLE = 1V$
Module Enable Voltage	V_{EME}	1.95	2.5	3.05	Vdc	
Module Disable Voltage	V_{EMD}	1.8	2.35	2.9	Vdc	
Disable Hysteresis	V_{EDH}		150		mV	
Enable Delay Time	t_{EE}		10		μs	
Disable Delay Time	t_{ED}		10		μs	
Maximum Capacitance	C_{EC}			1500	pF	
Maximum External Toggle Rate	f_{EXT}			1	Hz	
TRIM/SS						
Trim Voltage Reference	V_{REF}		1.22		Vdc	
Internal Capacitance	C_{REFI}		100		nF	
External Capacitance	C_{REF}			1	μF	
Internal Resistance	R_{REFI}		10		k Ω	
TM (Temperature Monitor)						
Temperature Coefficient	TM_{TC}		10		mV/ $^{\circ}K$	
Temperature Full Range Accuracy	TM_{ACC}	-5		5	$^{\circ}K$	
Drive Capability	I_{TM}	-100			μA	
TM Output Setting	V_{TM}		3.00		V	Ambient Temperature = 300 $^{\circ}K$

Electrical Specifications (continued)

Unless otherwise specified: $36V < V_{IN} < 75V$, $0A < I_{OUT} < 18A$, $-40^{\circ}C < T_{CASE} < 100^{\circ}C^{(1)}$

Parameter	Symbol	Min	Typ	Max	Units	Conditions
Thermal Specification						
Junction Temperature Shutdown	T_{MAX}	130	135	140	$^{\circ}C$	$V_{IN} = 48V$, Full 18A load
Junction-to-Case Thermal Impedance	$R\theta_{J-C}$		3		$^{\circ}C/W$	
Case-to-Ambient Thermal Impedance	$R\theta_{C-A}$		15		$^{\circ}C/W$	Mounted on 4.2 in ² 1oz. Cu 6 layer PCB 25 $^{\circ}C$
Regulatory Specification						
IEC 60950-1:2005 (2 nd Edition),						
EN 60950-1:2006						
IEC 61000-4-2						
UL 60950-1:2007						
CAN/CSA C22.2 NO. 60950-1-07						
Recommended Input Fuse Rating	I_{FUSE}	3		10	A	Fast acting LITTLEFUSE Nano ² Series Fuse

Mechanical Specifications

Parameter	Symbol	Min	Typ	Max	Units	Conditions
Mechanical Parameters						
PI3101 Package Weight	M_{PKG}		7.2		g	No heat sink
PI3101 Package Length	L_{PKG}		2.2		cm	No heat sink
			0.87		ins	No heat sink
PI3101 Package Width	W_{PKG}		1.65		cm	No heat sink
			0.65		ins	No heat sink
PI3101 Package Height	H_{PKG}		0.673		cm	No heat sink
			0.265		ins	No heat sink

Note (1): These parameters are not production tested but are guaranteed by design, characterization and correlation with statistical process control. Unless otherwise specified, ATE tests are completed at room temperature.

Note (2): Current flow sourced by a pin has a negative sign.

Functional Description:

Input Power Pins IN(+) and IN(-):

The input power pins on the PI3101 are connected to the input power source which can range from 36V to 75V DC. Under surge conditions, the PI3101 can withstand up to 100V DC for 100ms without incurring damage. The user should take care to avoid driving the input rails above the specified ratings. Since the PI3101 is designed with high reliability in mind, the input pins are continuously monitored. If the applied voltage exceeds the input over-voltage trip point (typically 80V) the conversion process shall be terminated immediately. The converter initiates soft-start automatically within 80ms after the input voltage is reduced back to the appropriate value. The input pins do not have reverse polarity protection. If the PI3101 is operated in an environment where reverse polarity is a concern, the user should consider using a polarity protection device such as a suitably rated diode. To avoid the high losses of using a diode, the user should consider the much higher efficiency Picor family of intelligent Cool-ORing™ solutions that can be used in reverse polarity applications. Information is available at picorpower.com.

The PI3101 will draw nearly zero current until the input voltage reaches the internal start up threshold. If the ENABLE pin is not pulled low by external circuitry, the output voltage will begin rising to its final value of 3.3V about 80ms after the input UV lockout releases. This will occur automatically even if the ENABLE pin is floating.

To help keep the source impedance low, the input to the PI3101 should be bypassed with (2) 1uF 100V ceramic capacitors of X7R dielectric in parallel with a low Q 47uF 100V electrolytic capacitor. To reduce EMI and reflected ripple current, a series inductor of 2 to 4.7uH can be added. The input traces to the module should be low impedance configured in such a manner as to keep stray inductance minimized.

ENABLE Pin:

The ENABLE pin serves as a multi-function pin for the PI3101. During normal operation, it outputs the on-board 4.9V regulator which can be used for trimming the module up. The ENABLE pin can also be used as a remote enable pin either from the secondary via an optocoupler and some external isolated bias supply or from the primary side through a small signal transistor, FET or any device that sinks 3.3mA, minimum. If the ENABLE pin is lower than 2.35V typical, the converter will be held off or shut down if already operating. A third feature is

offered in that during a fault condition such as output OVP, input UV or OV, or output current limit, the ENABLE pin is pulled low internally. This can be used as a signal to the user that a fault has occurred. Whenever the ENABLE pin is pulled low, the TRIM/SS pin follows, resetting the internal and external soft-start circuitry. All faults will pull ENABLE low including over temperature. If increased turn on delay is desired, the ENABLE pin can be bypassed with a small capacitor up to a maximum of 1500pF.

TRIM/SS Pin:

The TRIM/SS pin serves as another multi-purpose pin. First, it is used as the reference for the internal error amplifier. Connecting a resistor from TRIM/SS to SGND allows the reference to be margined down by as much as 10%. Connecting a resistor from TRIM/SS to ENABLE will allow the reference and output voltage to be margined up by 10%. If the user wishes a longer start up time, a small ceramic capacitor can be added to TRIM/SS to increase it. It is critical to connect any device between TRIM/SS and SGND and not -IN, otherwise high frequency noise will be introduced to the reference and possibly cause erratic operation.

TM Pin:

The TM pin serves as an output indicator of the internal package temperature which is within approximately +/- 5 °K of the hottest junction temperature. Because of this, it is a good indicator of a thermal overload condition. The output is a scaled, buffered analog voltage which indicates the internal temperature in degrees Kelvin. Upon a thermal overload, the TM pin is pulled low, indicating a thermal fault has occurred. Upon restart of the converter, the TM pin reverts back to a buffered monitor. The thermal shutdown function of the PI3101 is a fault feature which interrupts power processing if a certain maximum temperature is exceeded. TM can be monitored by an external microcontroller or circuit configured as an adaptive fan speed controller so that air flow in the system can be conveniently regulated.

SGND Pin:

The PI3101 SGND pin is the “quiet” control circuitry return. It is basically an extension of the internal signal ground. To avoid contamination and potential ground loops, this ground should NOT be connected to -IN since it is already star connected inside the package. Connect signal logic to SGND, not -IN.

Output Power Pins +OUT And -OUT:

The output power terminals OUT(+) and OUT(-) deliver the 18A maximum output current from the PI3101 through the J-lead output pins. This configuration allows for a low impedance output and should be connected to multi-layer PCB parallel planes for best performance. Due to the high switching frequency, output ripple and noise can be easily attenuated by adding just a few high quality X7R ceramic capacitors while retaining adequate transient response for most applications. The PI3101 does not require any feedback loop compensation nor does it require any opto-isolation. All isolation is contained within the package. This greatly simplifies the use of the converter and eliminates all outside influences of noise on the quality of the output voltage regulation and feedback loop. It is important for the user to minimize resistive connections from the load to the converter output and to keep stray inductance to a minimum for best regulation and transient response. The very small size footprint and height of the PI3101 allows the converter to be placed in the optimum location to allow for tight connections to the point of load. For those applications absolutely requiring very tight regulation, contact Picor Engineering at picorpower.com for a remote sense application circuit which can be used.

Typical Performance Characteristics:

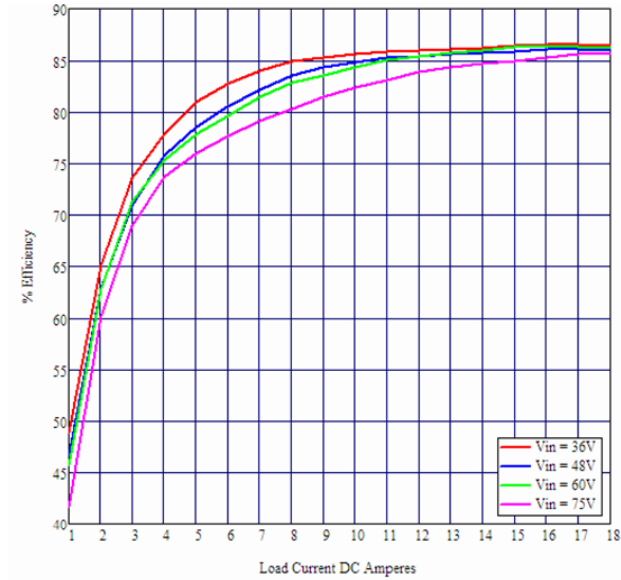

Figure 4 Conversion Efficiency (Tcase = 100°C)

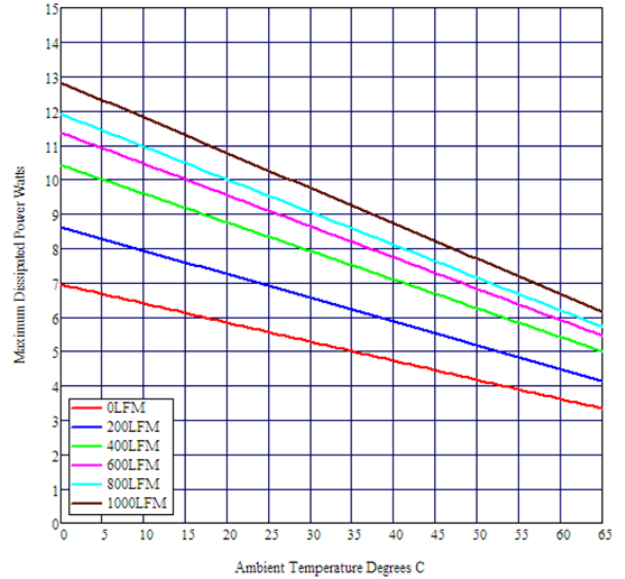

Figure 6 Power Dissipation Vs Temp (No Heat Sink)

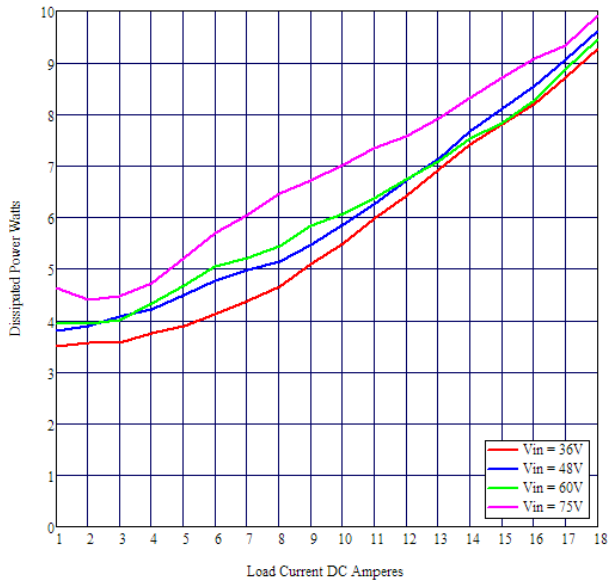

Figure 5 Power Dissipation Vs Io (Tcase = 100°C)

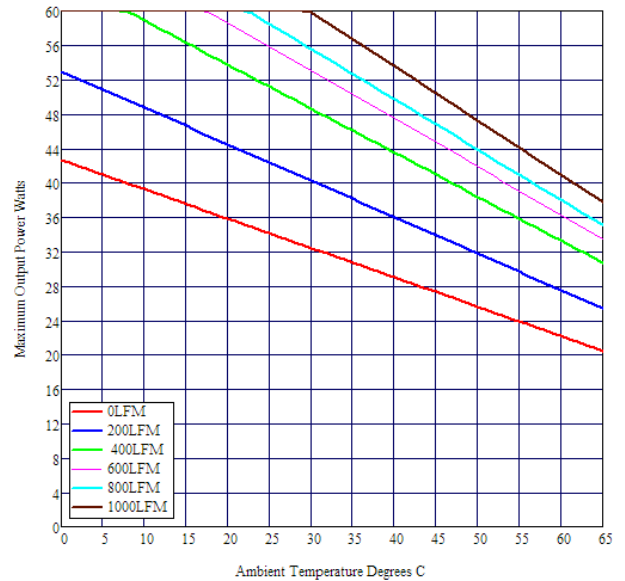

Figure 7 P_{OUT} Vs Temp (No Heat Sink)

Typical Performance Characteristics:

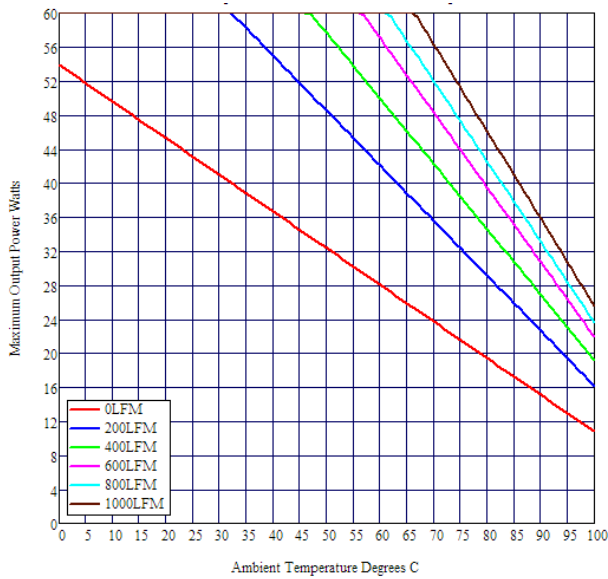

Figure 8 P_{OUT} Vs Temp Vs Flow (6.3mm Heat Sink)

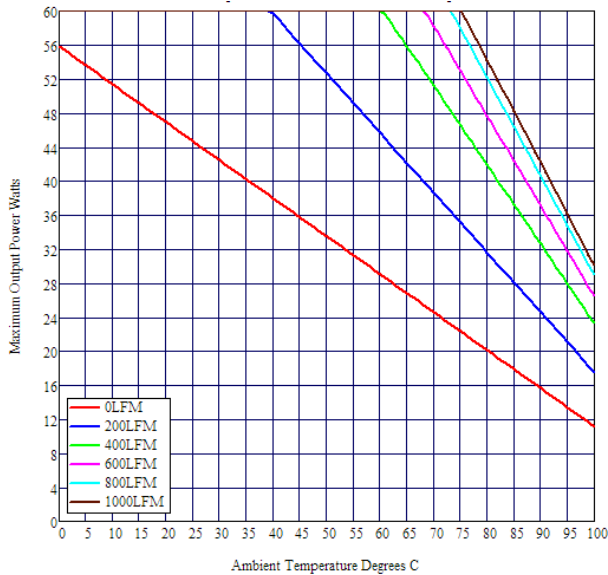

Figure 9 P_{OUT} Vs Temp Vs Flow (11mm Heat Sink)

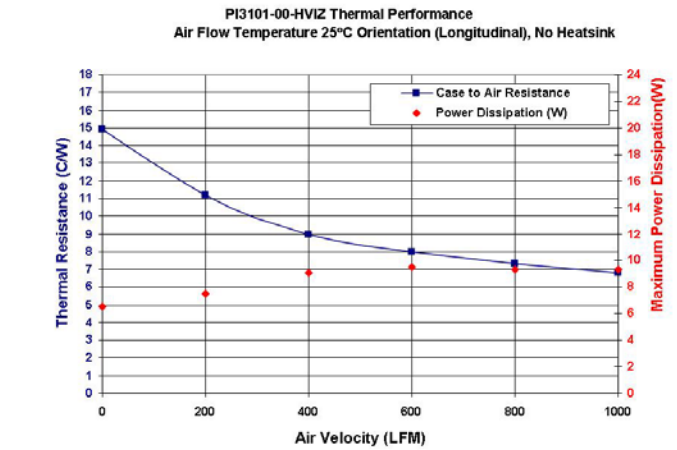

Figure 10 R_{ΘC-A} (No Heat Sink Longitudinal Flow)

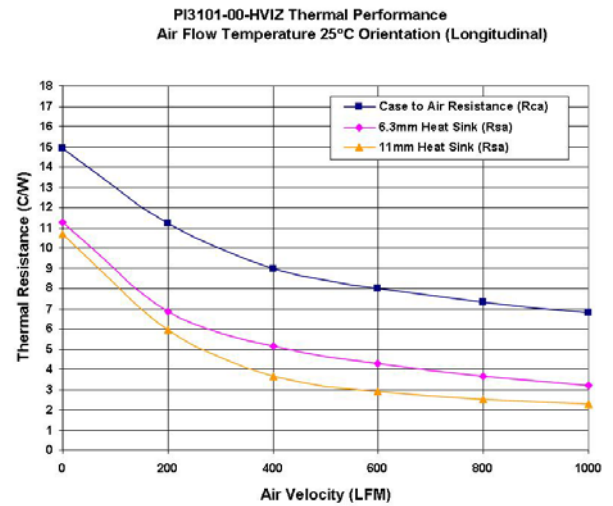

Figure 11 R_{ΘC-A} (Heat Sinks Longitudinal Flow)

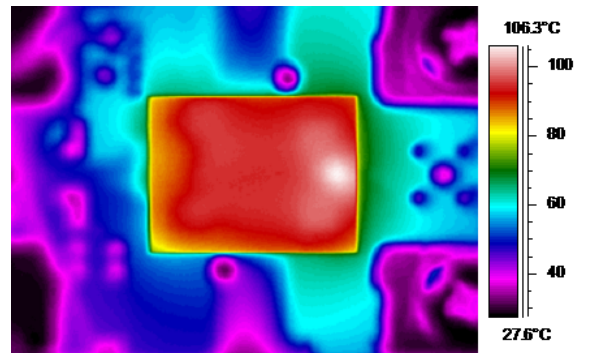

Figure 12 Thermal Image V_{IN} = 48V I_O = 18A Flow = 600LFM Longitudinal No Heat Sink Temp = 25°C

Typical Performance Characteristics:

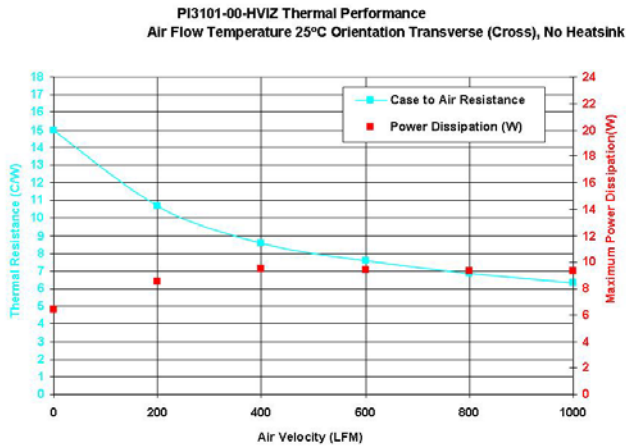

Figure 13 $R_{\theta C-A}$ (No Heat Sink Transverse Flow)

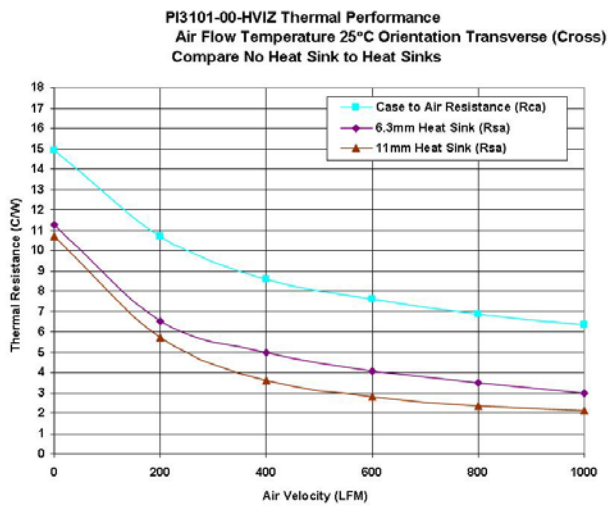
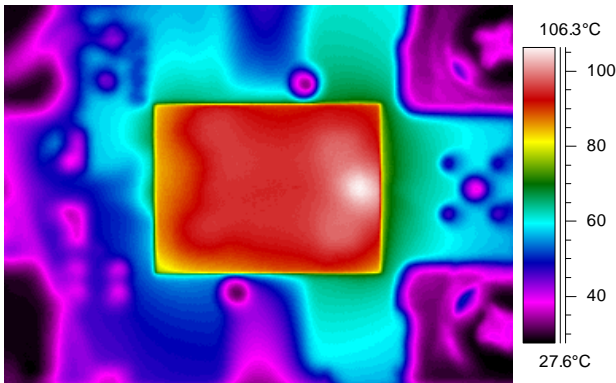

Figure 14 $R_{\theta C-A}$ (Heat Sinks Transverse Flow)



**Figure 15 Thermal Image $V_{IN} = 48V$ $I_O = 18A$
Flow = 600LFM X-Flow No Heat Sink Temp = 25°C**

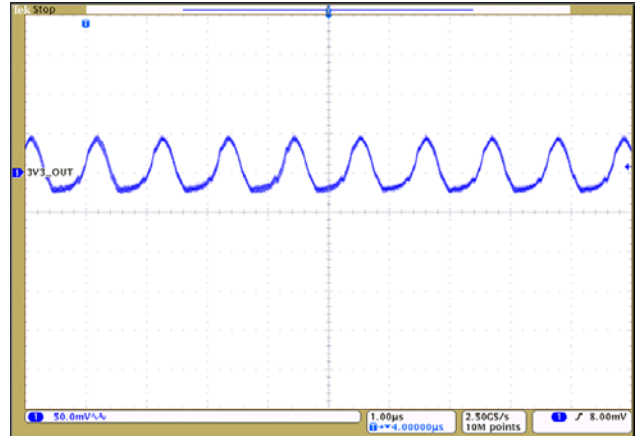

Figure 16 Output Ripple
($V_{IN} = 48V$ $I_O = 18A$ $C_{OUT} = 12X10\mu F$ X7R Ceramic)

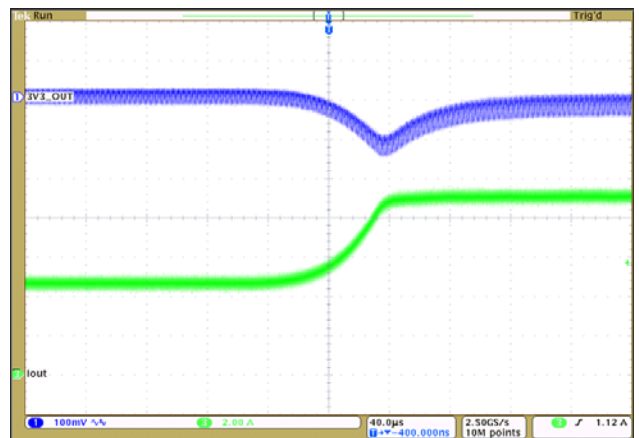

Figure 17 Transient Response 0.1A/µs
($V_{IN} = 48V$ $I_{OUT} = 4.5-9A$ $C_{OUT} = 12X10\mu F$ X7R Ceramic)

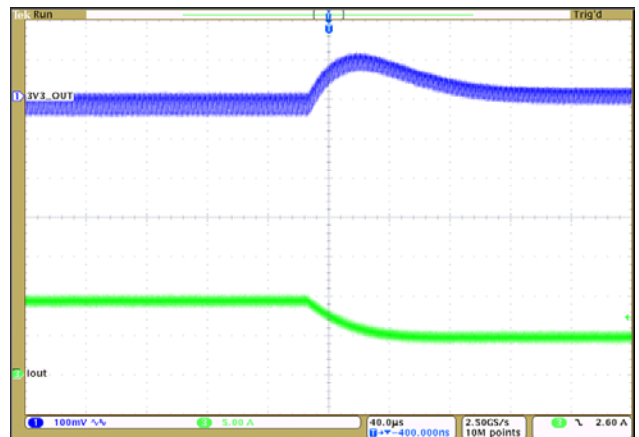

Figure 18 Transient Response 0.1A/µs
($V_{IN} = 48V$ $I_{OUT} = 9-4.5A$ $C_{OUT} = 12X10\mu F$ X7R Ceramic)

Typical Performance Characteristics:

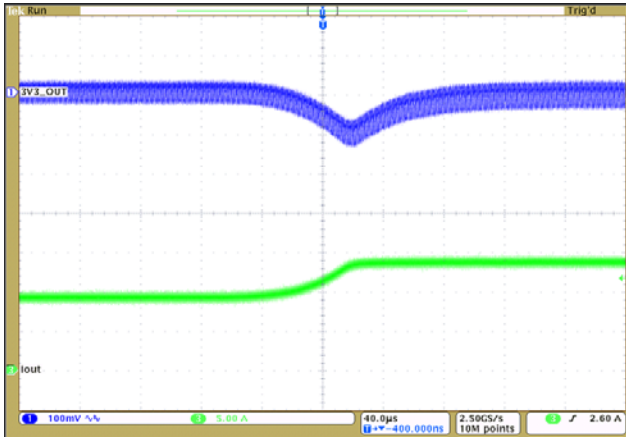

Figure 19 Transient Response 0.1A/μs
 ($V_{IN} = 48V$ $I_{OUT} = 9-13.5A$ $C_{OUT} = 12X10\mu F$ X7R Ceramic)

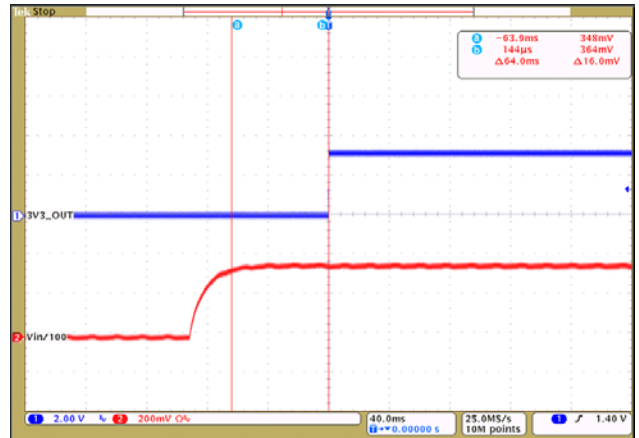

Figure 22 Start Up V_{IN} Vs V_{OUT}
 ($V_{IN} = 36V$ $I_{OUT} = 9A$ $C_{OUT} = 12X10\mu F$ X7R Ceramic)

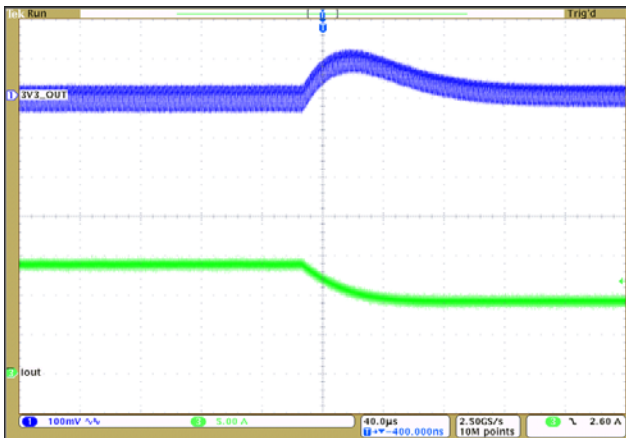

Figure 20 Transient Response 0.1A/μs
 ($V_{IN} = 48V$ $I_{OUT} = 9-13.5A$ $C_{OUT} = 12X10\mu F$ X7R Ceramic)

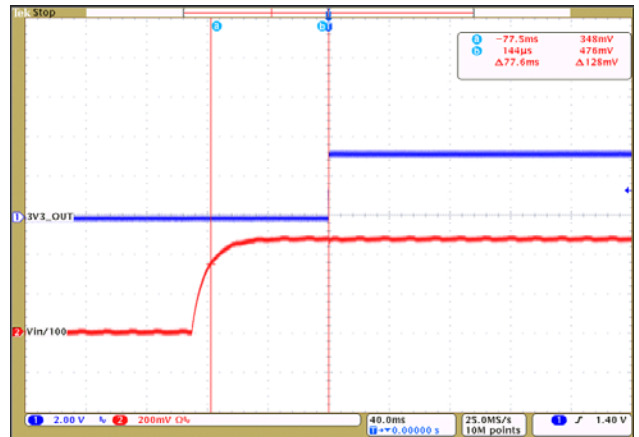

Figure 23 Start Up V_{IN} Vs V_{OUT}
 ($V_{IN} = 48V$ $I_{OUT} = 18A$ $C_{OUT} = 12X10\mu F$ X7R Ceramic)

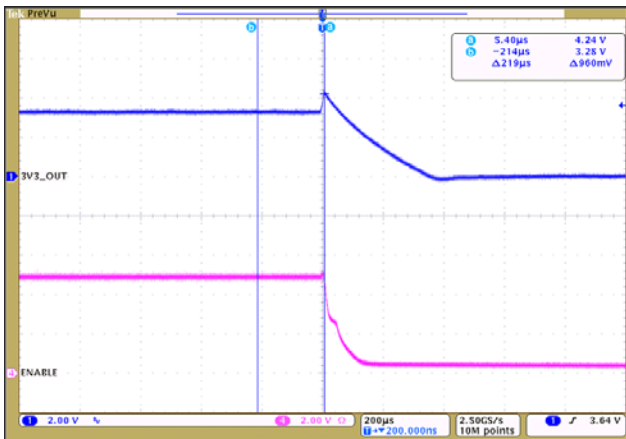

Figure 21 Output OVP Forced Via TRIM Pin
 ($V_{IN} = 48V$ $I_{OUT} = 9A$ $C_{OUT} = 12X10\mu F$ X7R Ceramic)

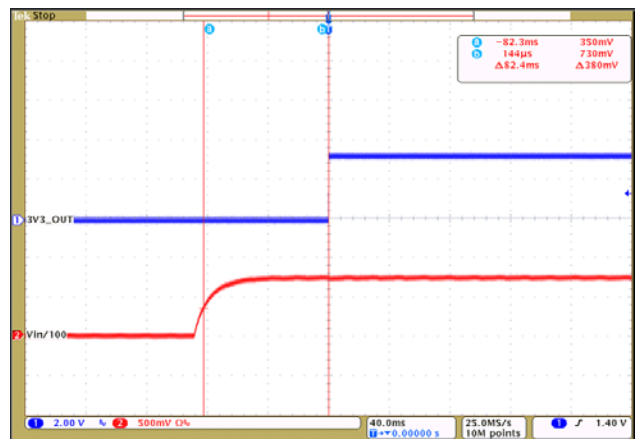

Figure 24 Start Up V_{IN} Vs V_{OUT}
 ($V_{IN} = 75V$ $I_{OUT} = 9A$ $C_{OUT} = 12X10\mu F$ X7R Ceramic)

Typical Performance Characteristics:

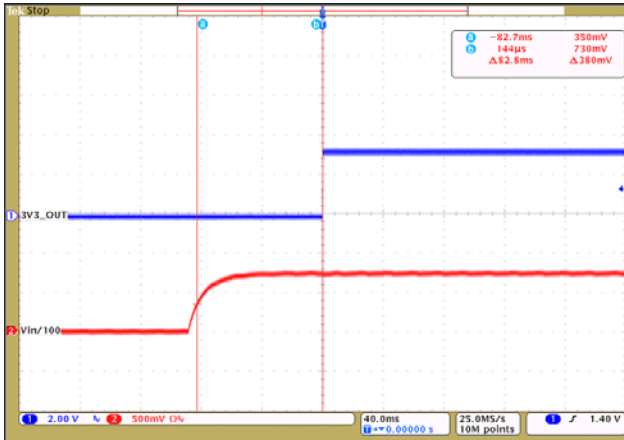

Figure 25 Start Up V_{IN} Vs V_{OUT}
 ($V_{IN} = 75V$ $I_{OUT} = 18A$ $C_{OUT} = 12X10\mu F$ X7R Ceramic)



Figure 28 Shut Down V_{IN} Vs V_{OUT}
 ($V_{IN} = 48V$ $I_{OUT} = 18A$ $C_{OUT} = 12X10\mu F$ X7R Ceramic)

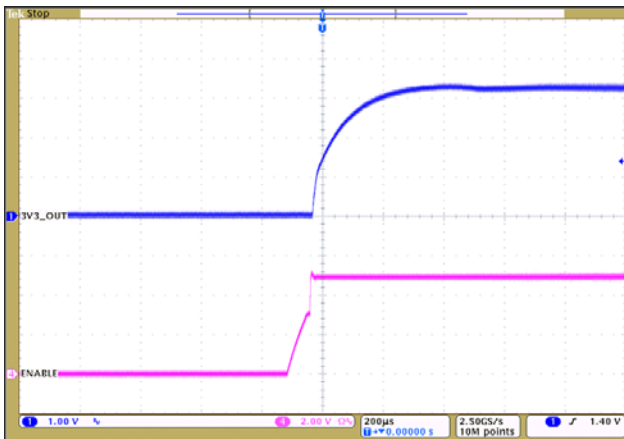

Figure 26 Start Up ENABLE Vs V_{OUT}
 ($V_{IN} = 36V$ $I_{OUT} = 18A$ $C_{OUT} = 12X10\mu F$ X7R Ceramic)

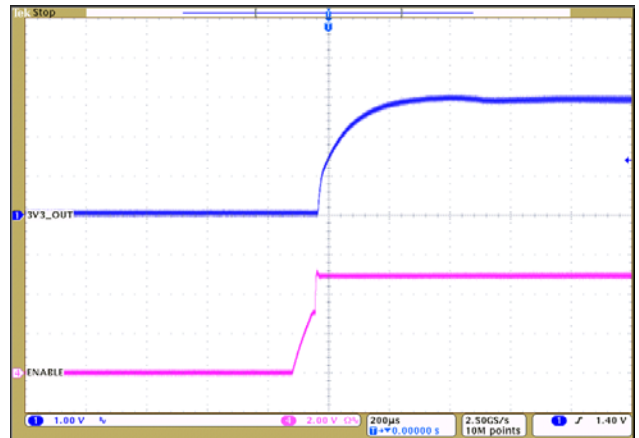

Figure 29 Start Up ENABLE Vs V_{OUT} Trim Down 10%
 ($V_{IN} = 36V$ $I_{OUT} = 18A$ $C_{OUT} = 12X10\mu F$ X7R Ceramic)

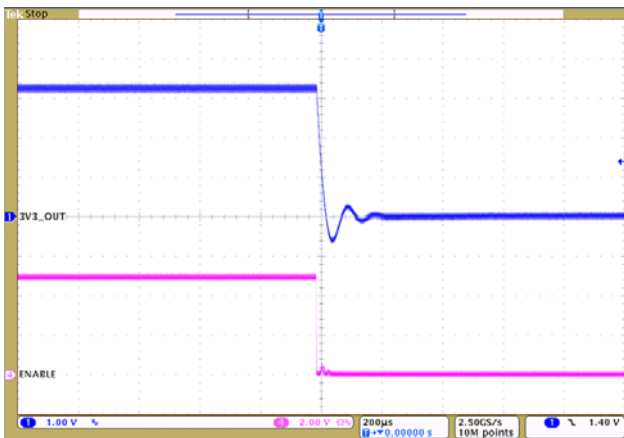

Figure 27 Shut Down ENABLE Vs V_{OUT}
 ($V_{IN} = 36V$ $I_{OUT} = 18A$ $C_{OUT} = 12X10\mu F$ X7R Ceramic)

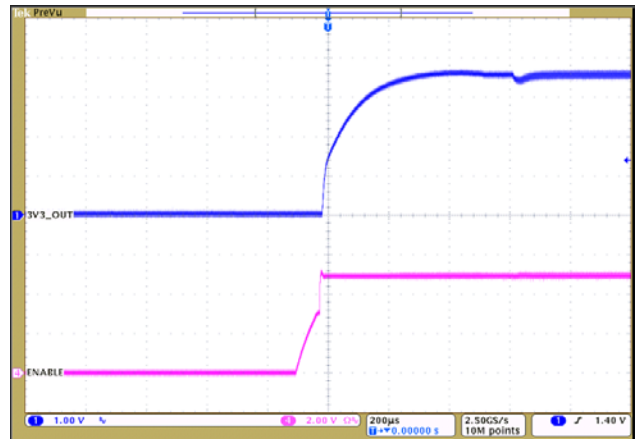

Figure 30 Start Up ENABLE Vs V_{OUT} Trim Up 10%
 ($V_{IN} = 36V$ $I_{OUT} = 18A$ $C_{OUT} = 12X10\mu F$ X7R Ceramic)

Typical Performance Characteristics:

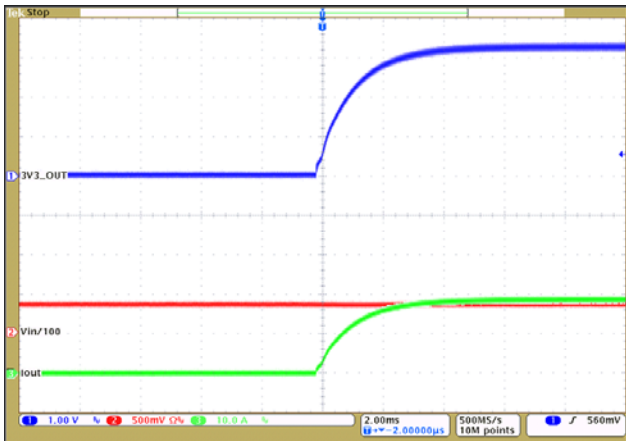

Figure 31 Start Up ENABLE Vs V_{OUT}
 ($V_{IN} = 36V$ $I_{OUT} = 18A$ Resistive $C_{OUT} = 4mF$ $C_{SS} = 0.1\mu F$)

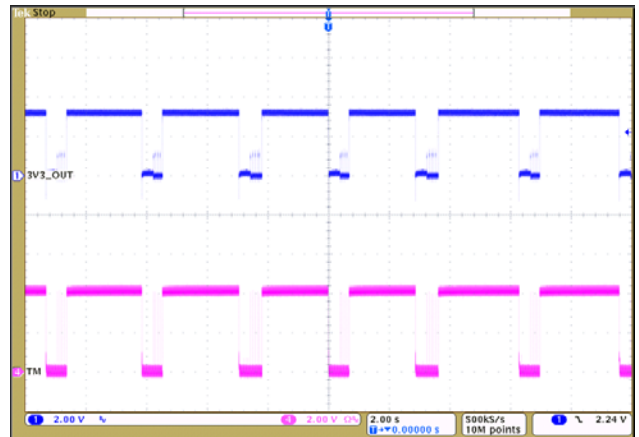

Figure 34 Forced Over Temperature
 ($V_{IN} = 75V$ $T_{CASE} = 135^{\circ}C$ $I_{OUT} = 27A$)

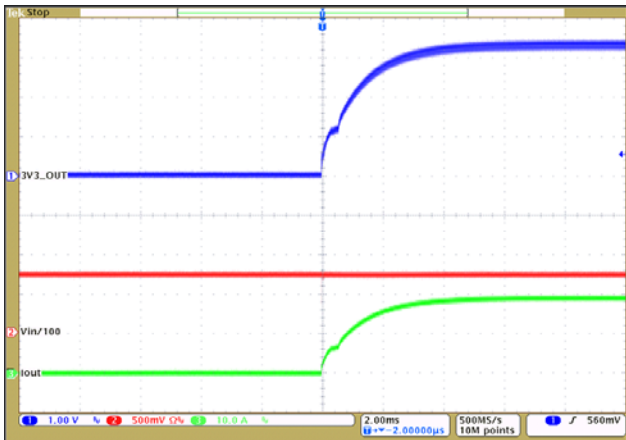

Figure 32 Start Up ENABLE Vs V_{OUT}
 ($V_{IN} = 75V$ $I_{OUT} = 18A$ Resistive $C_{OUT} = 4mF$ $C_{SS} = 0.1\mu F$)

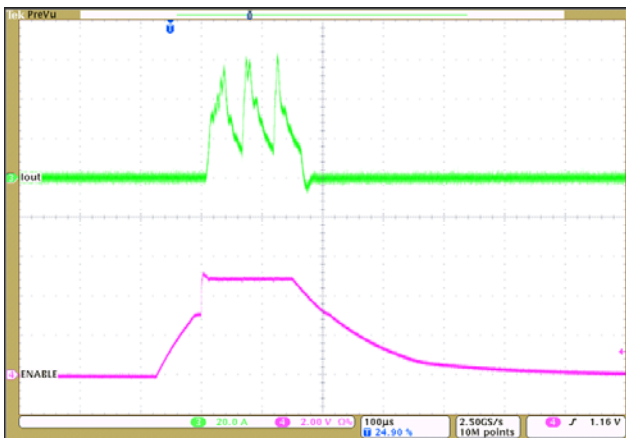

Figure 33 Start Up ENABLE Vs I_{OUT} Short Circuit
 ($V_{IN} = 48V$ Shorting Bar Across +OUT To -OUT)

Package Outline & Recommended PCB Land Pattern

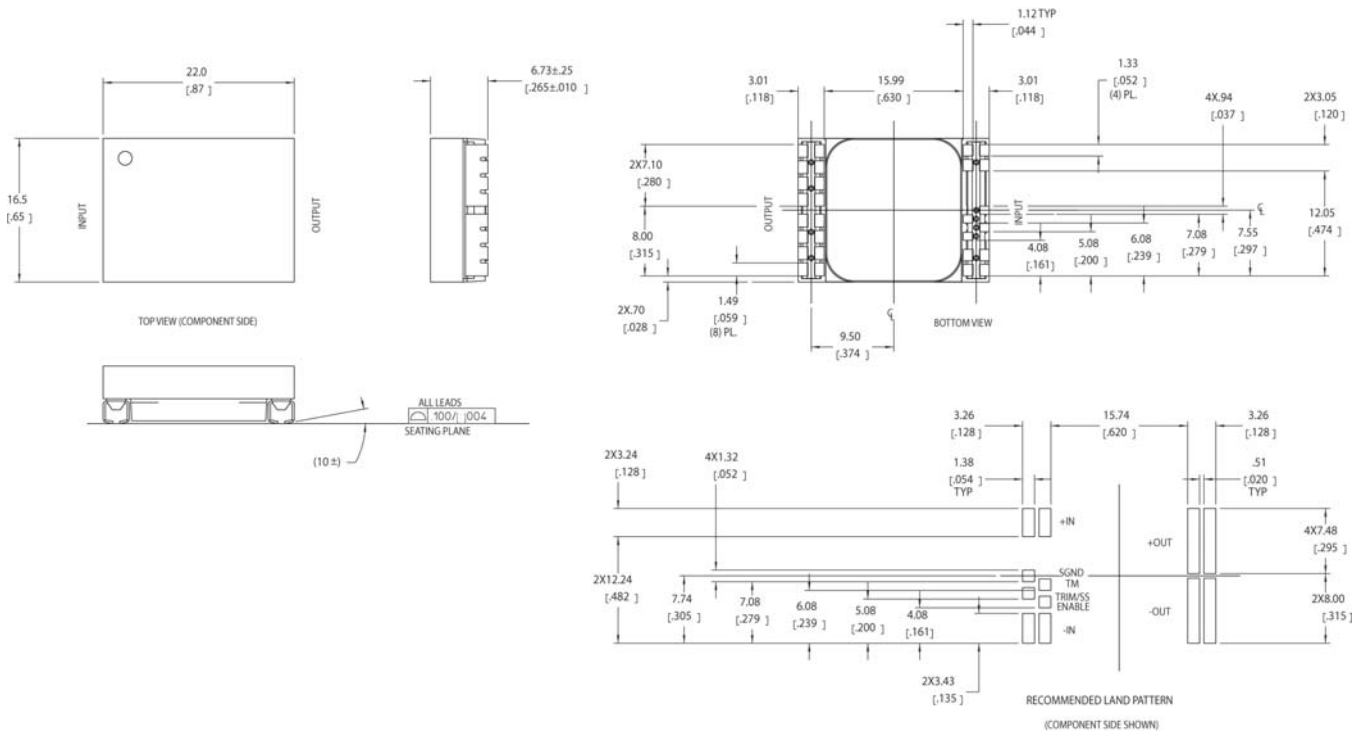

Figure 35

Ordering Information And Available Options:

Available Options – Heat Sinks:

At present, Picor offers four different heat sink options to accommodate the customers space and cooling needs. Heat sinks are available in two sizes, one with 6.3mm fins and the other with 11mm fins. Each of those heat sinks can be ordered with a specific air flow direction in mind, both X-Flow and longitudinal are supported.

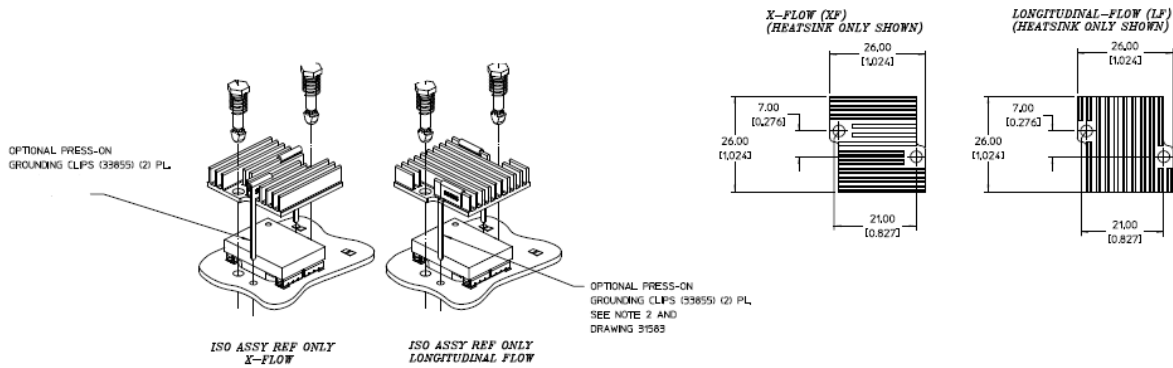

Figure 36 Picor PI3101 Heat Sink Options:

Part Number	Package
PI3101-00-HVIZ	0.87"(w) x 0.65"(l) x 0.265"(h)
32784	Transverse Fins Heatsink 11 mm *
32786	Transverse Fins Heatsink 6.3mm *
32783	Longitudinal Fins Heatsink 11 mm *
32785	Longitudinal Fins Heatsink 6.3 mm *

- * Assorted spring loaded push pins (not provided) are available to accommodate various PCB thicknesses. Please visit www.vicorpower.com for ordering information and details.

Ordering Information And Available Options:

Available Options – PI3101-EVAL1 Evaluation Board:

If you wish to evaluate the electrical and thermal performance of the PI3101, Picor can make available the PI3101-EVAL1 Evaluation Board. It comes with a fully populated high density isolated DC-DC power supply and a comprehensive user manual. For details contact Picor Applications Engineering or visit our website at www.picorpower.com.

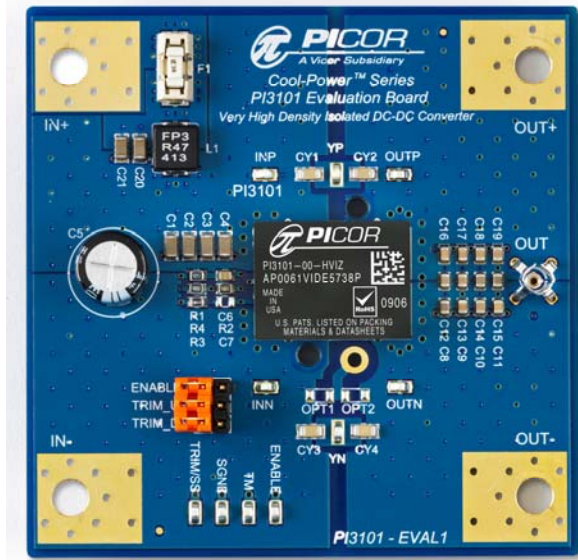

Figure 37 Picor PI3101-EVAL1 Evaluation Board (Actual Size)

Warranty

Vicor products are guaranteed for two years from date of shipment against defects in material or workmanship when in normal use and service. This warranty does not extend to products subjected to misuse, accident, or improper application or maintenance. Vicor shall not be liable for collateral or consequential damage. This warranty is extended to the original purchaser only.

EXCEPT FOR THE FOREGOING EXPRESS WARRANTY, VICOR MAKES NO WARRANTY, EXPRESS OR LIMITED, INCLUDING, BUT NOT LIMITED TO, THE WARRANTY OF MERCHANTABILITY OR FITNESS FOR A PARTICULAR PURPOSE.

Vicor will repair or replace defective products in accordance with its own best judgment. For service under this warranty, the buyer must contact Vicor to obtain a Return Material Authorization (RMA) number and shipping instructions. Products returned without prior authorization will be returned to the buyer. The buyer will pay all charges incurred in returning the product to the factory. Vicor will pay all reshipment charges if the product was defective within the terms of this warranty.

Information published by Vicor has been carefully checked and is believed to be accurate; however, no responsibility is assumed for inaccuracies. Vicor reserves the right to make changes to any products without further notice to improve reliability, function, or design. Vicor does not assume any liability arising out of the application or use of any product or circuit; neither does it convey any license under its patent rights nor the rights of others. Vicor general policy does not recommend the use of its components in life support applications wherein a failure or malfunction may directly threaten life or injury. Per Vicor Terms and Conditions of Sale, the user of Vicor components in life support applications assumes all risks of such use and indemnifies Vicor against all damages.

Vicor's comprehensive line of power solutions includes high density AC-DC and DC-DC modules and accessory components, fully configurable AC-DC and DC-DC power supplies, and complete custom power systems.

Information furnished by Vicor is believed to be accurate and reliable. However, no responsibility is assumed by Vicor for its use. Vicor components are not designed to be used in applications, such as life support systems, wherein a failure or malfunction could result in injury or death. All sales are subject to Vicor's Terms and Conditions of Sale, which are available upon request.

Specifications are subject to change without notice.

Intellectual Property Notice

Vicor and its subsidiaries own Intellectual Property (including U.S. and Foreign Patents and pending patent applications) related to the products described in this data sheet. Interested parties should contact Vicor's Intellectual Property Department.

The products described in this data sheet are protected by the following U.S. Patents Numbers: 6,788,033; 7,154,250; 7,561,446; 7,361,844; D496,906; D506,438; 6,940,013; 7,038,917; 6,969,909; 7,166,898; 6,421,262; 7,368,957; RE 40,072

Vicor Corporation
25 Frontage Road
Andover, MA 01810
USA

Picor Corporation
51 Industrial Drive
North Smithfield, RI 02896
USA

Customer Service: custserv@vicorpower.com
Technical Support: apps@vicorpower.com
Tel: 800-735-6200
Fax: 978-475-6715